

FCC DoC Test Report

Report No.: FD170627D07

Test Model: FE-1071

Received Date: Jun. 28, 2017

Test Date: Jun. 29 ~ Jul. 4, 2017

Issued Date: Jul. 12, 2017

Applicant: Vecow Co., Ltd.

Address: 12F., No. 111, Zhongcheng Rd., Tucheng Dist., New Taipei City 23674
Taiwan (R.O.C.)

Issued By: Bureau Veritas Consumer Products Services (H.K.) Ltd., Taoyuan Branch

Lab Address: No. 47-2, 14th Ling, Chia Pau Vil., Lin Kou Dist., New Taipei City, Taiwan
(R.O.C.)



This report is for your exclusive use. Any copying or replication of this report to or for any other person or entity, or use of our name or trademark, is permitted only with our prior written permission. This report sets forth our findings solely with respect to the test samples identified herein. The results set forth in this report are not indicative or representative of the quality or characteristics of the lot from which a test sample was taken or any similar or identical product unless specifically and expressly noted. Our report includes all of the tests requested by you and the results thereof based upon the information that you provided to us. You have 60 days from date of issuance of this report to notify us of any material error or omission caused by our negligence, provided, however, that such notice shall be in writing and shall specifically address the issue you wish to raise. A failure to raise such issue within the prescribed time shall constitute your unqualified acceptance of the completeness of this report, the tests conducted and the correctness of the report contents. Unless specifically mentioned, the uncertainty of measurement has been explicitly taken into account to declare the compliance or non-compliance to the specification. The report must not be used by the client to claim product certification, approval, or endorsement by NVLAP, NIST, or any agency of the federal government. The report must not be used by the client to claim product certification, approval, or endorsement by TAF or any government agencies.

Table of Contents

Release Control Record.....	3
1 Certificate of Conformity.....	4
2 Summary of Test Results.....	5
2.1 Measurement Uncertainty.....	5
2.2 Modification Record.....	5
3 General Information	6
3.1 Features of EUT.....	6
3.2 General Description of EUT.....	6
3.3 Operating Modes of EUT and Determination of Worst Case Operating Mode.....	6
3.4 Test Program Used and Operation Descriptions	6
3.5 Primary Clock Frequencies of Internal Source	6
4 Configuration and Connections with EUT.....	7
4.1 Connection Diagram of EUT and Peripheral Devices	7
4.2 Configuration of Peripheral Devices and Cable Connections.....	7
5 Conducted Emissions at Mains Ports	8
5.1 Limits	8
5.2 Test Instruments.....	8
5.3 Test Arrangement.....	9
5.4 Test Results	10
6 Radiated Emissions up to 1 GHz.....	12
6.1 Limits	12
6.2 Test Instruments.....	12
6.3 Test Arrangement.....	13
6.4 Test Results	14
7 Radiated Emissions above 1 GHz	16
7.1 Limits	16
7.2 Test Instruments.....	17
7.3 Test Arrangement.....	18
7.4 Test Results	19
8 Pictures of Test Arrangements	23
8.1 Conducted Emissions at Mains Ports.....	23
8.2 Radiated Emissions up to 1 GHz.....	24
8.3 Radiated Emissions above 1 GHz	25
Appendix – Information on the Testing Laboratories.....	26



Release Control Record

Issue No.	Description	Date Issued
FD170627D07	Original release.	Jul. 12, 2017

1 Certificate of Conformity

Product: Low Profile 2-port 10 GigE SFP+ Expansion Card

Brand: Vecow

Test Model: FE-1071

Sample Status: Engineering Sample

Applicant: Vecow Co., Ltd.

Test Date: Jun. 29 ~ Jul. 4, 2017

Standards: 47 CFR FCC Part 15, Subpart B, Class B
ICES-003:2016 Issue 6, Class B
ANSI C63.4:2014

The above equipment has been tested by **Bureau Veritas Consumer Products Services (H.K.) Ltd., Taoyuan Branch**, and found compliance with the requirement of the above standards. The test record, data evaluation & Equipment Under Test (EUT) configurations represented herein are true and accurate accounts of the measurements of the sample's EMC characteristics under the conditions specified in this report.

Prepared by :  , **Date:** Jul. 12, 2017
Vivian Chen / Specialist

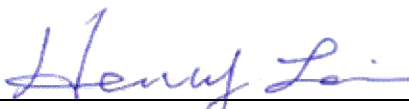
Approved by :  , **Date:** Jul. 12, 2017
Henry Lai / Director

2 Summary of Test Results

47 CFR FCC Part 15, Subpart B / ICES-003:2016 Issue 6, Class B

ANSI C63.4:2014

FCC Clause	ICES-003 Clause	Test Item	Result/Remarks	Verdict
15.107	6.1	AC Power Line Conducted Emissions	Minimum passing Class B margin is -8.00 dB at 0.18906 MHz	Pass
15.109	6.2.1	Radiated Emissions up to 1 GHz	Minimum passing Class B margin is -3.16 dB at 975.25 MHz	Pass
	6.2.2	Radiated Emissions above 1 GHz	Minimum passing Class B margin is -7.26 dB at 39139.20 MHz	Pass

Note: There is no deviation to the applied test methods and requirements covered by the scope of this report.

2.1 Measurement Uncertainty

Where relevant, the following measurement uncertainty levels have been estimated for tests performed on the EUT:

The listed uncertainties are the worst case uncertainty for the entire range of measurement. Please note that the uncertainty values are provided for informational purposes only and are not used in determining the PASS/FAIL results.

Measurement	Frequency	Expanded Uncertainty (k=2) (\pm)
Conducted Emissions at mains ports	150kHz ~ 30MHz	2.77 dB
Radiated Emissions up to 1 GHz	30MHz ~ 1GHz	3.89 dB
Radiated Emissions above 1 GHz	1GHz ~ 6GHz	5.12 dB
	Above 6GHz	5.09 dB

2.2 Modification Record

There were no modifications required for compliance.

3 General Information

3.1 Features of EUT

The tests reported herein were performed according to the method specified by Vecow Co., Ltd., for detailed feature description, please refer to the manufacturer's specifications or user's manual.

3.2 General Description of EUT

Product	Low Profile 2-port 10 GigE SFP+ Expansion Card
Brand	Vecow
Test Model	FE-1071
Sample Status	Engineering Sample
Operating Software	Win 10
Power Supply Rating	DC power from host equipment
Accessory Device	N/A
Data Cable Supplied	N/A

3.3 Operating Modes of EUT and Determination of Worst Case Operating Mode

Test modes are presented in the report as below.

Mode	Test Condition	Input Power (System)
1	EUT with system	120Vac/ 60Hz

3.4 Test Program Used and Operation Descriptions

- a. Installed the EUT into IPC.
- b. Turned on the power of all equipment.
- c. IPC ran a test program to enable all functions.
- d. IPC read and wrote messages to/ from int. HDD.
- e. IPC sent "H" messages to ext. LCD monitor. Then it displayed "H" messages on its screen.
- f. IPC sent messages to printer, and then printer printed it out.
- g. IPC sent messages to modem.
- h. Steps d-g were repeated.

3.5 Primary Clock Frequencies of Internal Source

The highest frequency generated or used within the EUT or on which the EUT operates or tunes is 10GHz, provided by Vecow Co., Ltd., for detailed internal source, please refer to the manufacturer's specifications.

4 Configuration and Connections with EUT

4.1 Connection Diagram of EUT and Peripheral Devices

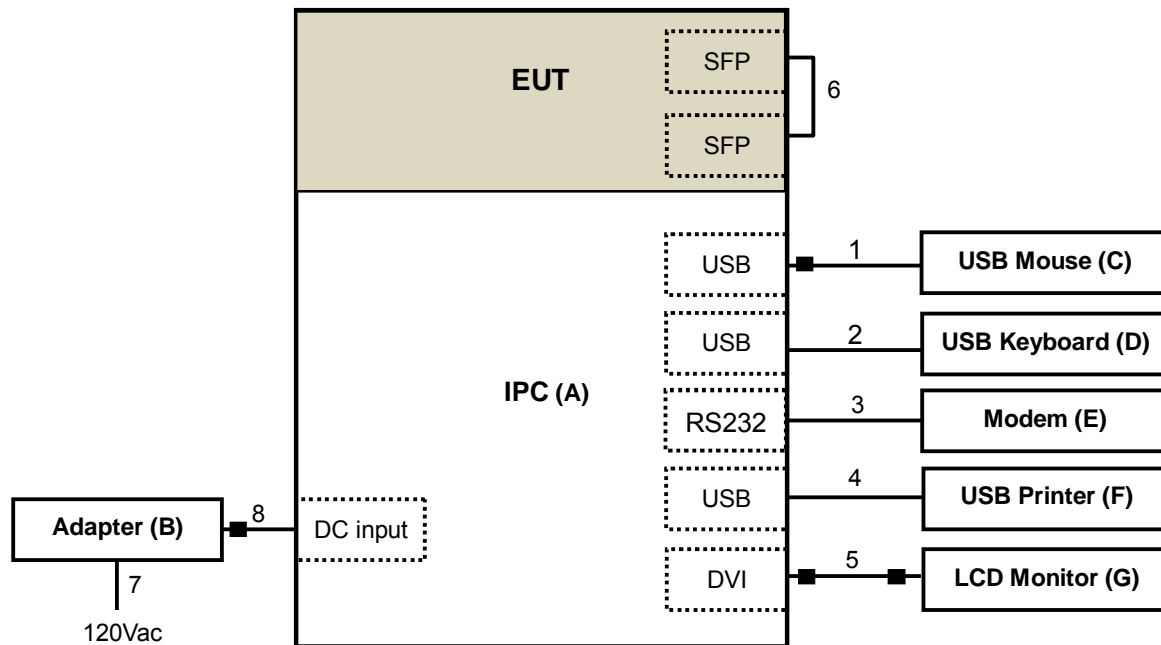

4.2 Configuration of Peripheral Devices and Cable Connections

ID	Product	Brand	Model No.	Serial No.	FCC ID	Remarks
A.	IPC	VECOW	RCS-9440	N/A	N/A	Supplied by client
B.	Adapter	MW	GS160A24	N/A	N/A	Supplied by client
C.	USB Mouse	Microsoft	1113	9170515772224	FCC DOC Approved	Provided by Lab
D.	USB KEYBOARD	BTC	5200U	G09302046627	E5XKB5122U	Provided by Lab
E.	MODEM	ACEEX	1414	980020512	IFAXDM1414	Provided by Lab
F.	PRINTER	HP	CV136-64001	CN55FCV012	B94SDGOB1191	Provided by Lab
G.	24" LCD MONITOR	DELL	U2410	CN082WXD728720 CC0KVL	FCC DoC Approved	Provided by Lab

Note: All power cords of the above support units are non-shielded (1.8m).

ID	Descriptions	Qty.	Length (m)	Shielding (Yes/No)	Cores (Qty.)	Remarks
1.	USB cable	1	1.8	Y	1	Provided by Lab
2.	USB cable	1	1.8	Y	0	Provided by Lab
3.	RS232 cable	1	1.2	Y	0	Provided by Lab
4.	USB cable	1	1.5	Y	0	Provided by Lab
5.	DVI cable	1	1.8	Y	2	Provided by Lab
6.	Coaxial cable	1	1.2	Y	0	Provided by Lab
7.	AC power cable	1	1.8	N	0	Supplied by client
8.	DC power cable	1	1.15	N	1	Supplied by client

Note: The core(s) is(are) originally attached to the cable(s).

5 Conducted Emissions at Mains Ports

5.1 Limits

Frequency (MHz)	Class A (dBuV)		Class B (dBuV)	
	Quasi-peak	Average	Quasi-peak	Average
0.15 - 0.5	79	66	66 - 56	56 - 46
0.50 - 5.0	73	60	56	46
5.0 - 30.0	73	60	60	50

Notes: 1. The lower limit shall apply at the transition frequencies.
 2. The limit decreases linearly with the logarithm of the frequency in the range of 0.15 to 0.50 MHz.

5.2 Test Instruments

Description & Manufacturer	Model No.	Serial No.	Cal. Date	Cal. Due
ROHDE & SCHWARZ TEST RECEIVER	ESCS 30	100290	Dec. 26, 2016	Dec. 25, 2017
ROHDE & SCHWARZ Artificial Mains Network (for EUT)	ESH2-Z5	100104	Dec. 01, 2016	Nov. 30, 2017
LISN With Adapter (for EUT)	AD10	C09Ada-001	Dec. 01, 2016	Nov. 30, 2017
ROHDE & SCHWARZ Artificial Mains Network (for peripherals)	ESH3-Z5	847265/023	Oct. 27, 2016	Oct. 26, 2017
SCHWARZBECK Artificial Mains Network (For EUT)	NNLK8129	8129229	May 09, 2017	May 08, 2018
Software	Cond_V7.3.7.4	NA	NA	NA
RF cable (JYEBAO) With 10dB PAD	5D-FB	Cable-C09.01	Feb. 21, 2017	Feb. 20, 2018
SUHNER Terminator (For ROHDE & SCHWARZ LISN)	65BNC-5001	E1-010789	May 18, 2017	May 17, 2018
ROHDE & SCHWARZ Artificial Mains Network (For TV EUT)	ESH3-Z5	100220	Nov. 08, 2016	Nov. 07, 2017
LISN With Adapter (for TV EUT)	100220	N/A	Nov. 08, 2016	Nov. 07, 2017

Notes: 1. The calibration interval of the above test instruments is 12 months and the calibrations are traceable to NML/ROC and NIST/USA.
 2. The test was performed in Shielded Room No. 9.
 3. The VCCI Site Registration No. C-1312.
 4. Tested Date: Jun. 29, 2017

5.3 Test Arrangement

- The EUT was placed 0.4 meters from the conducting wall of the shielded room with EUT being connected to the power mains through a line impedance stabilization network (LISN). Other support units were connected to the power mains through another LISN. The two LISNs provide 50 Ohm/ 50uH of coupling impedance for the measuring instrument.
- Both lines of the power mains connected to the EUT were checked for maximum conducted interference.
- The test results of conducted emissions at mains ports are recorded of six worst margins for quasi-peak (mandatory) [and average (if necessary)] values against the limits at frequencies of interest unless the margin is 20 dB or greater.

Note: The resolution bandwidth and video bandwidth of test receiver is 9kHz for quasi-peak detection (QP) and average detection (AV) at frequency 0.15MHz-30MHz.

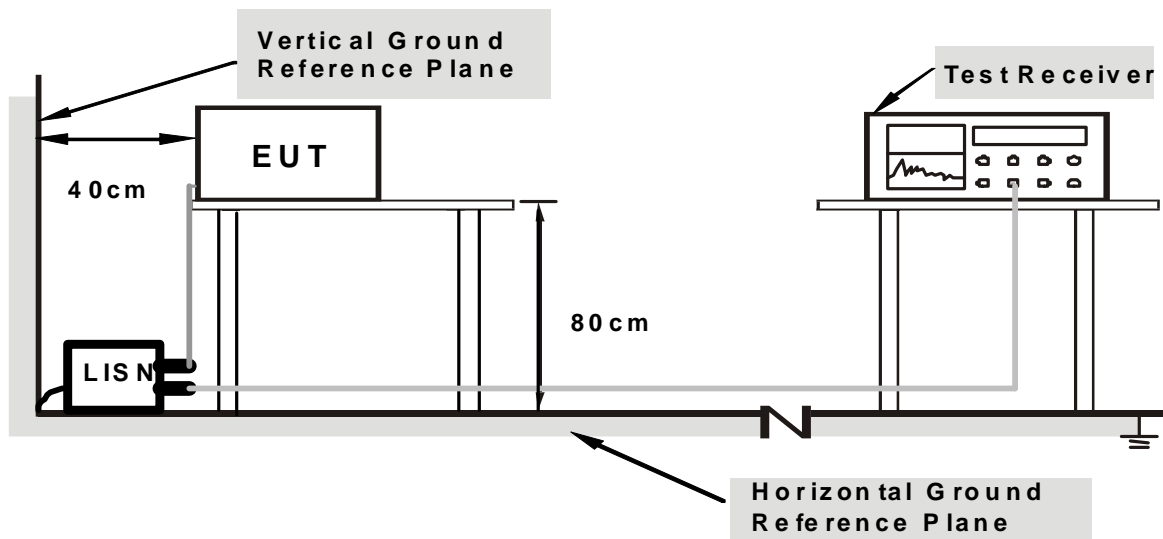

Note: Support units were connected to second LISN.

For the actual test configuration, please refer to the related item – Photographs of the Test Configuration.

5.4 Test Results

Frequency Range	150kHz ~ 30MHz	Detector Function & Resolution Bandwidth	Quasi-Peak (QP) / Average (AV), 9kHz
Input Power (System)	120Vac, 60Hz	Environmental Conditions	24°C, 77%RH
Tested by	Chiawei Lin		
Test Mode	Mode 1		

Phase Of Power : Line (L)										
No	Frequency (MHz)	Correction Factor (dB)	Reading Value (dBuV)		Emission Level (dBuV)		Limit (dBuV)		Margin (dB)	
			Q.P.	AV.	Q.P.	AV.	Q.P.	AV.	Q.P.	AV.
1	0.16172	10.09	32.01	7.90	42.10	17.99	65.38	55.38	-23.28	-37.39
2	0.18906	10.10	40.47	35.64	50.57	45.74	64.08	54.08	-13.51	-8.34
3	0.25156	10.13	24.91	12.84	35.04	22.97	61.71	51.71	-26.67	-28.74
4	0.81016	10.23	19.86	12.71	30.09	22.94	56.00	46.00	-25.91	-23.06
5	10.34375	10.73	18.80	14.78	29.53	25.51	60.00	50.00	-30.47	-24.49
6	23.70313	11.11	23.14	15.69	34.25	26.80	60.00	50.00	-25.75	-23.20

Remarks:

1. Q.P. and AV. are abbreviations of quasi-peak and average individually.
2. The emission levels of other frequencies were very low against the limit.
3. Margin value = Emission level – Limit value
4. Correction factor = Insertion loss + Cable loss
5. Emission Level = Correction Factor + Reading Value

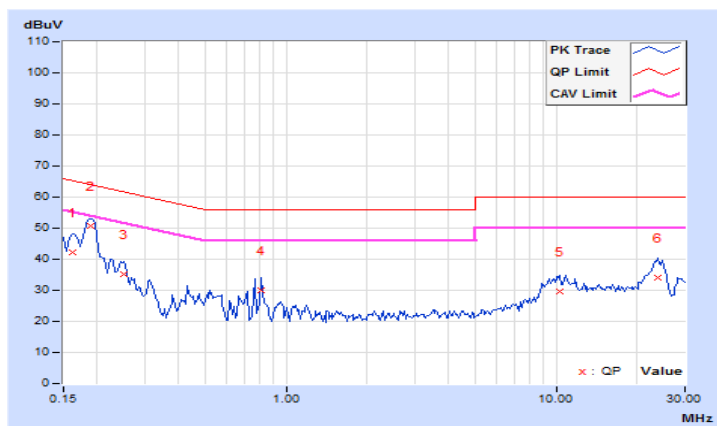

Frequency Range	150kHz ~ 30MHz	Detector Function & Resolution Bandwidth	Quasi-Peak (QP) / Average (AV), 9kHz
Input Power (System)	120Vac, 60Hz	Environmental Conditions	24°C, 77%RH
Tested by	Chiawei Lin		
Test Mode	Mode 1		

Phase Of Power : Neutral (N)										
No	Frequency (MHz)	Correction Factor (dB)	Reading Value (dBuV)		Emission Level (dBuV)		Limit (dBuV)		Margin (dB)	
			Q.P.	AV.	Q.P.	AV.	Q.P.	AV.	Q.P.	AV.
1	0.16172	10.09	31.83	18.12	41.92	28.21	65.38	55.38	-23.46	-27.17
2	0.18906	10.05	38.82	36.03	48.87	46.08	64.08	54.08	-15.21	-8.00
3	0.31406	10.11	23.59	19.22	33.70	29.33	59.86	49.86	-26.16	-20.53
4	0.43125	10.17	15.24	9.26	25.41	19.43	57.23	47.23	-31.82	-27.80
5	0.76328	10.28	19.29	11.16	29.57	21.44	56.00	46.00	-26.43	-24.56
6	9.99728	10.69	20.33	17.60	31.02	28.29	60.00	50.00	-28.98	-21.71
7	25.03516	10.64	21.30	13.64	31.94	24.28	60.00	50.00	-28.06	-25.72

Remarks:

1. Q.P. and AV. are abbreviations of quasi-peak and average individually.
2. The emission levels of other frequencies were very low against the limit.
3. Margin value = Emission level – Limit value
4. Correction factor = Insertion loss + Cable loss
5. Emission Level = Correction Factor + Reading Value

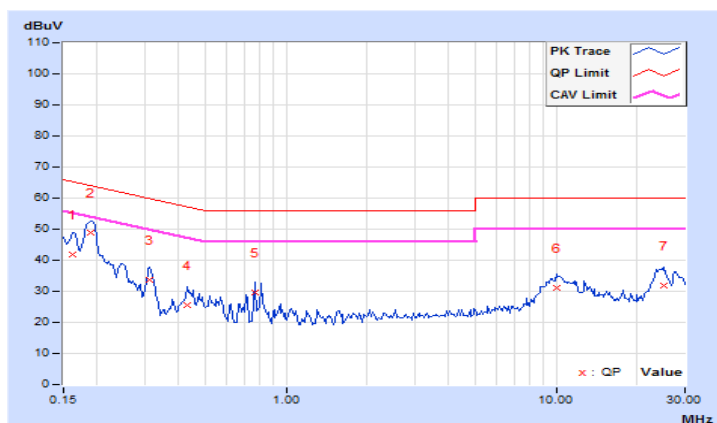

6 Radiated Emissions up to 1 GHz

6.1 Limits

Emissions radiated outside of the specified bands, shall be according to the general radiated limits as following:

Radiated Emissions Limits at 10 meters (dB μ V/m)				
Frequencies (MHz)	FCC 15B / ICES-003, Class A	FCC 15B / ICES-003, Class B	CISPR 22, Class A	CISPR 22, Class B
30-88	39	29.5	40	30
88-216	43.5	33.1		
216-230	46.4	35.6		
230-960			47	37
960-1000	49.5	43.5		

Radiated Emissions Limits at 3 meters (dB μ V/m)				
Frequencies (MHz)	FCC 15B / ICES-003, Class A	FCC 15B / ICES-003, Class B	CISPR 22, Class A	CISPR 22, Class B
30-88	49.5	40	50.5	40.5
88-216	54	43.5		
216-230	56.9	46		
230-960			57.5	47.5
960-1000	60	54		

- Notes:
1. The lower limit shall apply at the transition frequencies.
 2. Emission level (dB μ V/m) = 20 log Emission level (μ V/m).
 3. QP detector shall be applied if not specified.

6.2 Test Instruments

Description & Manufacturer	Model No.	Serial No.	Cal. Date	Cal. Due
ROHDE & SCHWARZ TEST RECEIVER	ESCI	100412	Sep. 05, 2016	Sep. 04, 2017
Schwarzbeck BILOG Antenna	VULB9168	9168-479	Dec. 16, 2016	Dec. 15, 2017
Agilent Preamplifier	8447D	2944A08312	Feb. 21, 2017	Feb. 20, 2018
CT Turn Table	TT100	CT-0055	NA	NA
CT Tower	AT100	CT-0055	NA	NA
Software	Radiated_V7.6.15.9.5	NA	NA	NA
ADT RF Switches BOX	EM-H-01-1	1002	Sep. 22 2016	Sep. 21, 2017
WOKEN RF cable With 5dB PAD	8D	CABLE-ST6-01	Sep. 22 2016	Sep. 21, 2017

- Notes:
1. The calibration interval of the above test instruments is 12 months and the calibrations are traceable to NML/ROC and NIST/USA.
 2. The test was performed in Open Site No. 6.
 3. The VCCI Site Registration No. R-728.
 4. The FCC Site Registration No. 90427.
 5. Tested Date: Jul. 4, 2017

6.3 Test Arrangement

- The EUT was placed on the top of a rotating table 0.8 meters above the ground at an accredited test facility. The table was rotated 360 degrees to determine the position of the highest radiation.
- The EUT was set 10 meters away from the interference-receiving antenna, which was mounted on the top of a variable-height antenna tower.
- The antenna is a broadband antenna, and its height is varied from one meter to four meters above the ground to determine the maximum value of the field strength. Both horizontal and vertical polarizations of the antenna are set to make the measurement.
- For each suspected emission, the EUT was arranged to its worst case and then the antenna was tuned to heights from 1 meter to 4 meters and the rotatable table was turned from 0 degrees to 360 degrees to find the maximum reading.
- The test-receiver system was set to quasi-peak detect function and specified bandwidth with maximum hold mode when the test frequency is below 1 GHz.

Note: The resolution bandwidth and video bandwidth of test receiver/spectrum analyzer is 120kHz for quasi-peak detection (QP) at frequency below 1GHz.

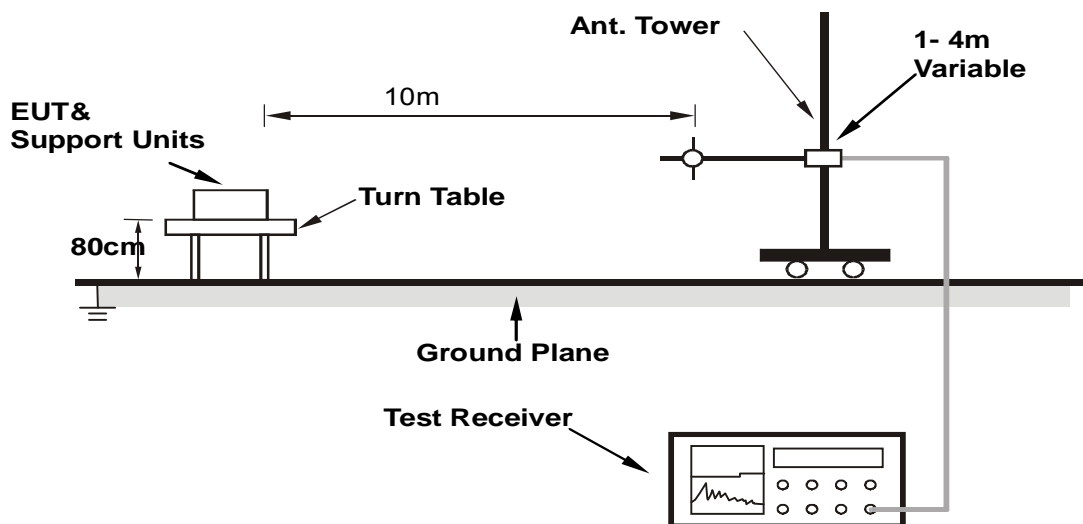

For the actual test configuration, please refer to the related item – Photographs of the Test Configuration.

6.4 Test Results

Frequency Range	30MHz ~ 1GHz	Detector Function & Resolution Bandwidth	Quasi-Peak (QP), 120kHz
Input Power (System)	120Vac, 60Hz	Environmental Conditions	33°C, 58%RH
Tested by	Vincent Lin		
Test Mode	Mode 1		

Antenna Polarity & Test Distance : Horizontal at 10 m

No	Frequency (MHz)	Emission Level (dBuV/m)	Limit (dBuV/m)	Margin (dB)	Antenna Height (m)	Table Angle (Degree)	Raw Value (dBuV)	Correction Factor (dB/m)
1	125.01	23.93 QP	30.00	-6.07	4.00 H	72	34.76	-10.83
2	131.21	24.09 QP	30.00	-5.91	4.00 H	159	34.43	-10.34
3	162.00	24.01 QP	30.00	-5.99	4.00 H	60	32.95	-8.94
4	170.40	25.08 QP	30.00	-4.92	4.00 H	119	34.48	-9.40
5	220.40	24.15 QP	30.00	-5.85	4.00 H	202	35.68	-11.53
6	426.83	30.69 QP	37.00	-6.31	1.93 H	226	35.19	-4.50
7	453.59	31.87 QP	37.00	-5.13	3.17 H	269	35.97	-4.10
8	639.25	29.72 QP	37.00	-7.28	2.63 H	153	29.96	-0.24
9	975.25	33.84 QP	37.00	-3.16	1.14 H	70	28.02	5.82
10	1000.00	32.49 QP	37.00	-4.51	1.00 H	275	26.27	6.22

Remarks:

1. Emission Level(dBuV/m) = Raw Value(dBuV) + Correction Factor(dB/m)
2. Correction Factor(dB/m) = Antenna Factor (dB/m) + Cable Factor (dB)
– Pre-Amplifier Factor (dB)
3. The other emission levels were very low against the limit.
4. Margin value = Emission level – Limit value

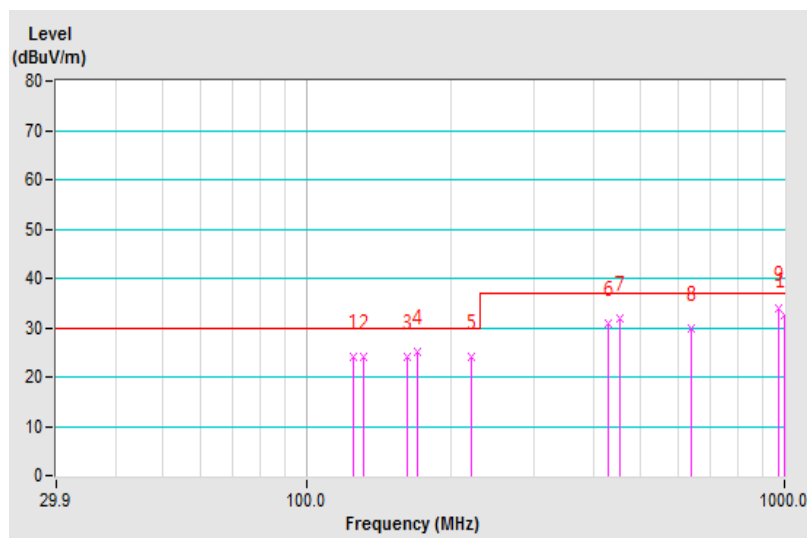

Frequency Range	30MHz ~ 1GHz	Detector Function & Resolution Bandwidth	Quasi-Peak (QP), 120kHz
Input Power (System)	120Vac, 60Hz	Environmental Conditions	33°C, 58%RH
Tested by	Vincent Lin		
Test Mode	Mode 1		

Antenna Polarity & Test Distance : Vertical at 10 m								
No	Frequency (MHz)	Emission Level (dBuV/m)	Limit (dBuV/m)	Margin (dB)	Antenna Height (m)	Table Angle (Degree)	Raw Value (dBuV)	Correction Factor (dB/m)
1	47.18	24.32 QP	30.00	-5.68	1.69 V	94	33.77	-9.45
2	85.68	22.86 QP	30.00	-7.14	1.58 V	218	37.80	-14.94
3	125.08	25.72 QP	30.00	-4.28	1.00 V	337	36.54	-10.82
4	132.40	25.84 QP	30.00	-4.16	1.00 V	313	36.06	-10.22
5	168.09	25.71 QP	30.00	-4.29	1.00 V	172	34.94	-9.23
6	224.51	21.98 QP	30.00	-8.02	1.00 V	246	33.30	-11.32
7	364.75	32.86 QP	37.00	-4.14	1.00 V	104	39.00	-6.14
8	399.99	28.96 QP	37.00	-8.04	1.94 V	270	34.29	-5.33
9	446.50	29.62 QP	37.00	-7.38	3.43 V	259	33.69	-4.07
10	990.25	33.40 QP	37.00	-3.60	2.60 V	133	27.40	6.00

Remarks:

1. Emission Level(dBuV/m) = Raw Value(dBuV) + Correction Factor(dB/m)
2. Correction Factor(dB/m) = Antenna Factor (dB/m) + Cable Factor (dB) – Pre-Amplifier Factor (dB)
3. The other emission levels were very low against the limit.
4. Margin value = Emission level – Limit value

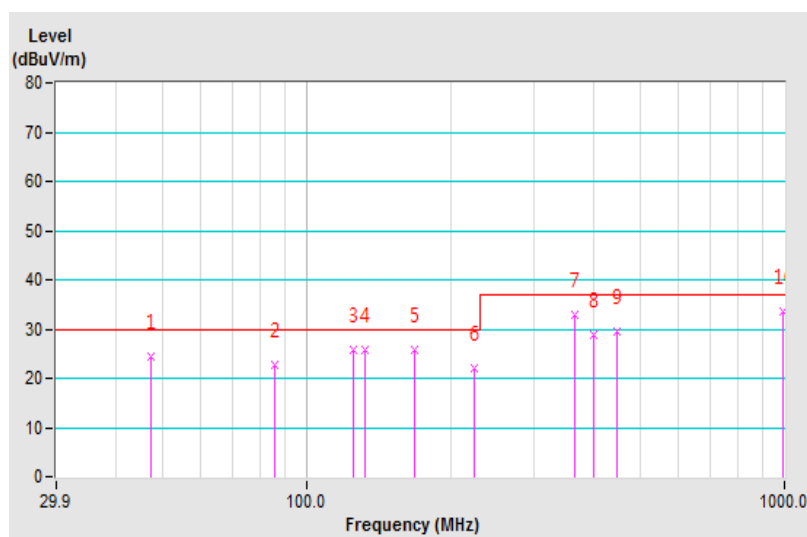

7 Radiated Emissions above 1 GHz

7.1 Limits

Emissions radiated outside of the specified bands, shall be according to the general radiated limits as following:

Radiated Emissions Limits at 10 meters (dB μ V/m)				
Frequencies (MHz)	FCC 15B / ICES-003, Class A	FCC 15B / ICES-003, Class B	CISPR 22, Class A	CISPR 22, Class B
1000-3000	Avg: 49.5	Avg: 43.5	Not defined	Not defined
Above 3000	Peak: 69.5	Peak: 63.5	Not defined	Not defined

Radiated Emissions Limits at 3 meters (dB μ V/m)				
Frequencies (MHz)	FCC 15B / ICES-003, Class A	FCC 15B / ICES-003, Class B	CISPR 22, Class A	CISPR 22, Class B
1000-3000	Avg: 60	Avg: 54	Avg: 56 Peak: 76	Avg: 50 Peak: 70
Above 3000	Peak: 80	Peak: 74	Avg: 60 Peak: 80	Avg: 54 Peak: 74

Radiated Emissions Limits at 1.5 meters (dB μ V/m)				
Frequencies (MHz)	FCC 15B / ICES-003, Class A	FCC 15B / ICES-003, Class B	CISPR 22, Class A	CISPR 22, Class B
Above 18000	Avg: 66 Peak: 86	Avg: 60 Peak: 80	Avg: 66 Peak: 86	Avg: 60 Peak: 80

- Notes:
1. The lower limit shall apply at the transition frequencies.
 2. Emission level (dB μ V/m) = 20 log Emission level (uV/m).
 3. As shown in 15.35(b), for frequencies above 1000MHz, the field strength limits are based on average detector, however, the peak field strength of any emission shall not exceed the maximum permitted average limits, specified above by more than 20dB under any condition of modulation.

Frequency Range (For unintentional radiators)

Highest frequency generated or used in the device or on which the device operates or tunes (MHz)	Upper frequency of measurement range (MHz)
Below 1.705	30
1.705-108	1000
108-500	2000
500-1000	5000
Above 1000	5th harmonic of the highest frequency or 40GHz, whichever is lower

7.2 Test Instruments

Description & Manufacturer	Model No.	Serial No.	Cal. Date	Cal. Due
Agilent Spectrum	E4446A	MY51100009	Jun. 01, 2017	May 31, 2018
Agilent Test Receiver	N9038A	MY50010135	Jun. 29, 2017	Jun. 28, 2018
Agilent Preamplifier	8449B	3008A02367	Feb. 22, 2017	Feb. 21, 2018
MITEQ Preamplifier	AMF-6F-260400-33-8P	892164	Feb. 21, 2017	Feb. 20, 2018
EMCI Preamplifier	EMC184045B	980235	Feb. 22, 2017	Feb. 21, 2018
Schwarzbeck Horn Antenna	BBHA-9170	212	Dec. 30, 2016	Dec. 29, 2017
EMCO Horn Antenna	3115	9312-4192	Dec. 28, 2016	Dec. 27, 2017
Max Full. Turn Table & Tower	MF7802	MF780208103	NA	NA
Software	Radiated_V8.7.08	NA	NA	NA
SUHNER RF cable With 4dB PAD	SF106-18	Cable-CH7	Aug. 15, 2016	Aug. 14, 2017
SUHNER RF cable With 3/4dB PAD	SF102	Cable-CH7-3.6m	Aug. 15, 2016	Aug. 14, 2017
MICRO-TRONICS Notch filter	BRC50703-01	010	May 31, 2017	May 30, 2018
MICRO-TRONICS Band Pass Filter	BRM17690	005	May 31, 2017	May 30, 2018

- Notes:
1. The calibration interval of the above test instruments is 12 months and the calibrations are traceable to NML/ROC and NIST/USA.
 2. The test was performed in Chamber No. 7.
 3. The Industry Canada Reference No. IC 7450E-7.
 4. The FCC Site Registration No. 127748.
 5. The VCCI Site Registration No. G-39.
 6. Tested Date: Jun. 30, 2017

7.3 Test Arrangement

- The EUT was placed on the top of a rotating table 0.8 meters above the ground at an accredited chamber room. The table was rotated 360 degrees to determine the position of the highest radiation.
- The EUT was set 3 meters / 1.5 meters away from the interference-receiving antenna, which was mounted on the top of a variable-height antenna tower.
- The height of antenna can be varied from one meter to four meters, the height of adjustment depends on the EUT height and the antenna 3dB beamwidth both, to detect the maximum value of the field strength. Both horizontal and vertical polarizations of the antenna are set to make the measurement.
- For each suspected emission, the EUT was arranged to its worst case and then the antenna was tuned to heights and the rotatable table was turned from 0 degrees to 360 degrees to find the maximum reading.
- The spectrum analyzer system was set to peak and average detect function and specified bandwidth with maximum hold mode when the test frequency is above 1 GHz.

Note:

- The resolution bandwidth of test receiver/spectrum analyzer is 1MHz and video bandwidth is 3MHz for Peak detection (PK) at frequency above 1GHz. The resolution bandwidth of test receiver/spectrum analyzer is 1 MHz for Average detection (AV) at frequency above 1GHz.
- For measurement of frequency 1 GHz ~ 18 GHz, the EUT was set 3 meters away from the receiver antenna
- For measurement of frequency 18 GHz ~ 40 GHz, the EUT was set 1.5 meters away from the receiver antenna

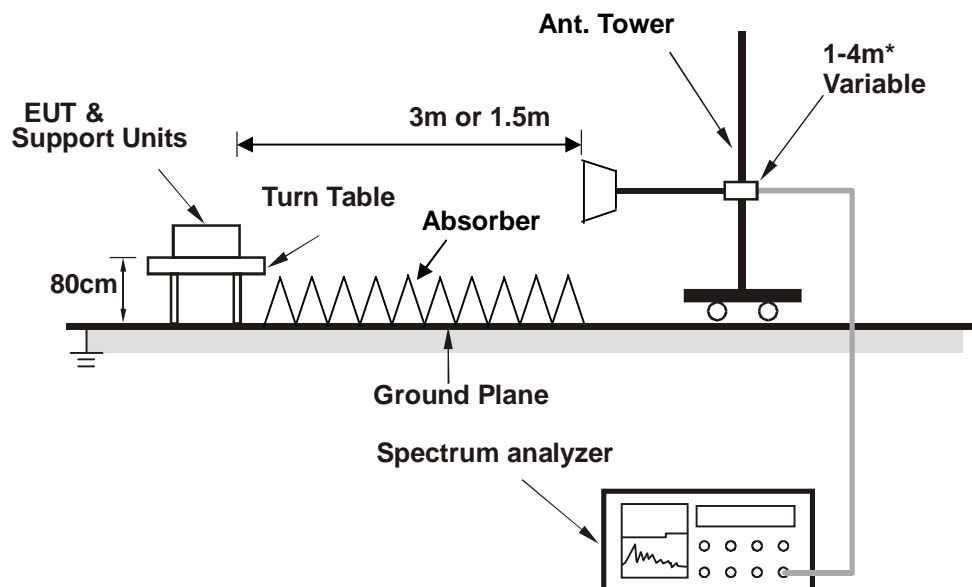

* :depends on the EUT height and the antenna 3dB beamwidth both.

For the actual test configuration, please refer to the related item – Photographs of the Test Configuration.

7.4 Test Results

Frequency Range	1GHz ~ 18GHz	Detector Function & Resolution Bandwidth	Peak (PK) / Average (AV), 1MHz
Input Power (System)	120Vac, 60Hz	Environmental Conditions	25°C, 75%RH
Tested by	Paul Chen		
Test Mode	Mode 1		

Antenna Polarity & Test Distance : Horizontal at 3 m

No	Frequency (MHz)	Emission Level (dBuV/m)	Limit (dBuV/m)	Margin (dB)	Antenna Height (m)	Table Angle (Degree)	Raw Value (dBuV)	Correction Factor (dB/m)
1	1074.82	43.62 PK	74.00	-30.38	1.24 H	137	46.50	-2.88
2	1074.82	32.25 AV	54.00	-21.75	1.24 H	137	35.13	-2.88
3	1540.05	49.00 PK	74.00	-25.00	1.17 H	209	51.31	-2.31
4	1540.05	38.91 AV	54.00	-15.09	1.17 H	209	41.22	-2.31
5	2129.08	49.52 PK	74.00	-24.48	1.08 H	236	49.45	0.07
6	2129.08	31.58 AV	54.00	-22.42	1.08 H	236	31.51	0.07

Remarks:

1. Emission Level(dBuV/m) = Raw Value(dBuV) + Correction Factor(dB/m)
2. Correction Factor(dB/m) = Antenna Factor (dB/m) + Cable Factor (dB) – Pre-Amplifier Factor (dB)
3. The other emission levels were very low against the limit.
4. Margin value = Emission level – Limit value

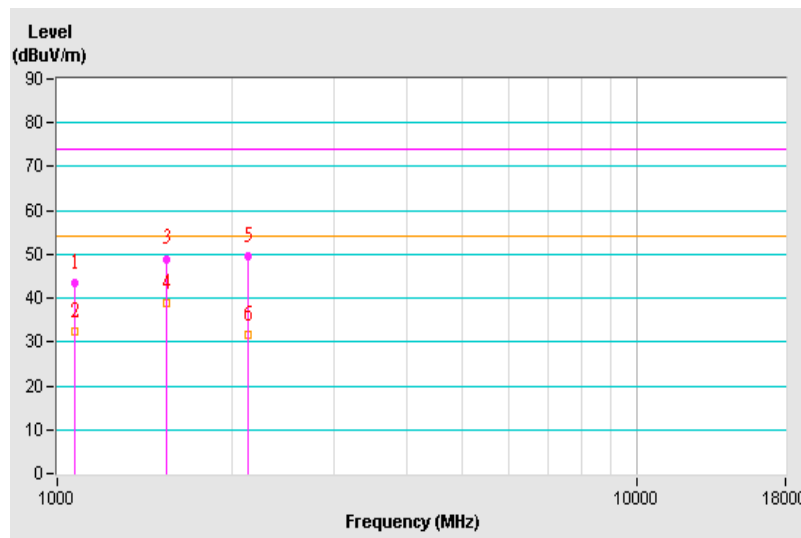

Frequency Range	1GHz ~ 18GHz	Detector Function & Resolution Bandwidth	Peak (PK) / Average (AV), 1MHz
Input Power (System)	120Vac, 60Hz	Environmental Conditions	25°C, 75%RH
Tested by	Paul Chen		
Test Mode	Mode 1		

Antenna Polarity & Test Distance : Vertical at 3 m								
No	Frequency (MHz)	Emission Level (dBuV/m)	Limit (dBuV/m)	Margin (dB)	Antenna Height (m)	Table Angle (Degree)	Raw Value (dBuV)	Correction Factor (dB/m)
1	1075.00	44.57 PK	74.00	-29.43	1.09 V	172	47.45	-2.88
2	1075.00	35.84 AV	54.00	-18.16	1.09 V	172	38.72	-2.88
3	1540.04	47.99 PK	74.00	-26.01	1.54 V	10	50.30	-2.31
4	1540.04	37.58 AV	54.00	-16.42	1.54 V	10	39.89	-2.31
5	2125.28	49.22 PK	74.00	-24.78	1.62 V	175	49.15	0.07
6	2125.28	31.76 AV	54.00	-22.24	1.62 V	175	31.69	0.07

Remarks:

1. Emission Level(dBuV/m) = Raw Value(dBuV) + Correction Factor(dB/m)
2. Correction Factor(dB/m) = Antenna Factor (dB/m) + Cable Factor (dB) – Pre-Amplifier Factor (dB)
3. The other emission levels were very low against the limit.
4. Margin value = Emission level – Limit value

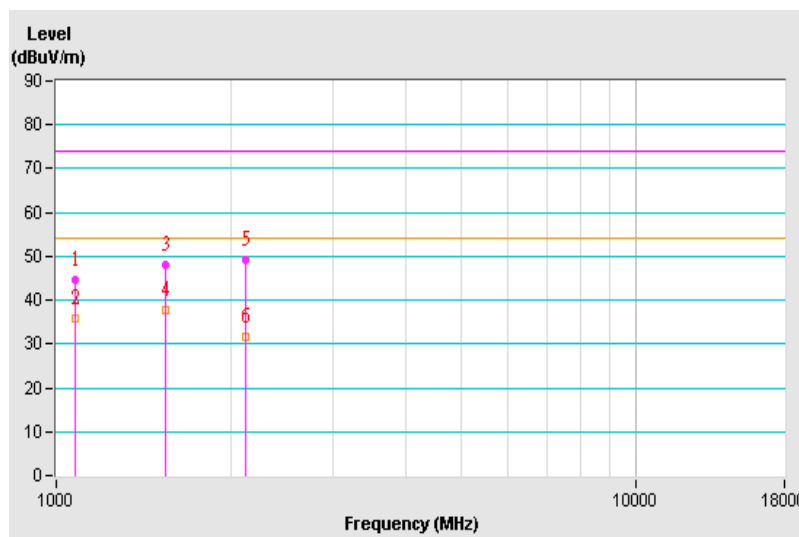

Frequency Range	18GHz ~ 40GHz	Detector Function & Resolution Bandwidth	Peak (PK) / Average (AV), 1MHz
Input Power (System)	120Vac, 60Hz	Environmental Conditions	25°C, 75%RH
Tested by	Paul Chen		
Test Mode	Mode 1		

Antenna Polarity & Test Distance : Horizontal at 1.5 m								
No	Frequency (MHz)	Emission Level (dBuV/m)	Limit (dBuV/m)	Margin (dB)	Antenna Height (m)	Table Angle (Degree)	Raw Value (dBuV)	Correction Factor (dB/m)
1	31655.41	61.34 PK	80.00	-18.66	1.43 H	193	56.85	4.49
2	31655.41	46.69 AV	60.00	-13.31	1.43 H	193	42.20	4.49
3	36101.71	61.83 PK	80.00	-18.17	1.02 H	83	58.08	3.75
4	36101.71	47.64 AV	60.00	-12.36	1.02 H	83	43.89	3.75
5	38953.06	66.83 PK	80.00	-13.17	1.31 H	266	58.37	8.46
6	38953.06	52.43 AV	60.00	-7.57	1.31 H	266	43.97	8.46

Remarks:

1. Emission Level(dBuV/m) = Raw Value(dBuV) + Correction Factor(dB/m)
2. Correction Factor(dB/m) = Antenna Factor (dB/m) + Cable Factor (dB) – Pre-Amplifier Factor (dB)
3. The other emission levels were very low against the limit.
4. Margin value = Emission level – Limit value

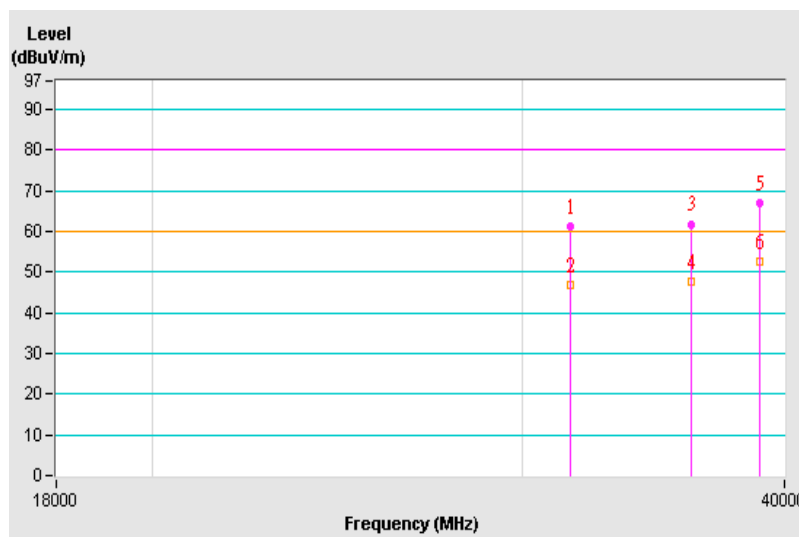

Frequency Range	18GHz ~ 40GHz	Detector Function & Resolution Bandwidth	Peak (PK) / Average (AV), 1MHz
Input Power (System)	120Vac, 60Hz	Environmental Conditions	25°C, 75%RH
Tested by	Paul Chen		
Test Mode	Mode 1		

Antenna Polarity & Test Distance : Vertical at 1.5 m								
No	Frequency (MHz)	Emission Level (dBuV/m)	Limit (dBuV/m)	Margin (dB)	Antenna Height (m)	Table Angle (Degree)	Raw Value (dBuV)	Correction Factor (dB/m)
1	31501.89	59.74 PK	80.00	-20.26	1.13 V	0	54.57	5.17
2	31501.89	46.86 AV	60.00	-13.14	1.13 V	0	41.69	5.17
3	35839.93	61.40 PK	80.00	-18.60	1.74 V	16	57.33	4.07
4	35839.93	47.65 AV	60.00	-12.35	1.74 V	16	43.58	4.07
5	39139.20	66.63 PK	80.00	-13.37	1.52 V	176	57.53	9.10
6	39139.20	52.74 AV	60.00	-7.26	1.52 V	176	43.64	9.10

Remarks:

1. Emission Level(dBuV/m) = Raw Value(dBuV) + Correction Factor(dB/m)
2. Correction Factor(dB/m) = Antenna Factor (dB/m) + Cable Factor (dB) – Pre-Amplifier Factor (dB)
3. The other emission levels were very low against the limit.
4. Margin value = Emission level – Limit value

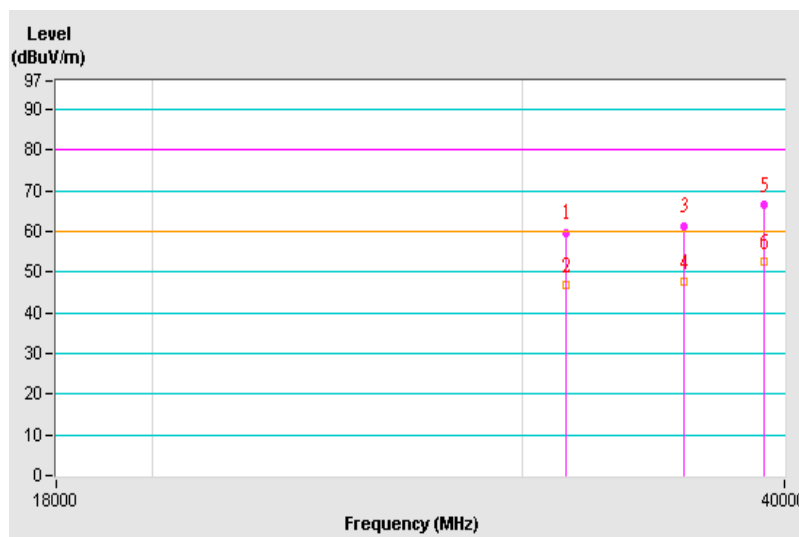

8 Pictures of Test Arrangements

8.1 Conducted Emissions at Mains Ports



8.2 Radiated Emissions up to 1 GHz



8.3 Radiated Emissions above 1 GHz



Appendix – Information on the Testing Laboratories

We, Bureau Veritas Consumer Products Services (H.K.) Ltd., Taoyuan Branch, were founded in 1988 to provide our best service in EMC, Radio, Telecom and Safety consultation. Our laboratories are accredited and approved according to ISO/IEC 17025.

If you have any comments, please feel free to contact us at the following:

Linko EMC/RF Lab

Tel: 886-2-26052180

Fax: 886-2-26051924

Hsin Chu EMC/RF/Telecom Lab

Tel: 886-3-6668565

Fax: 886-3-6668323

Hwa Ya EMC/RF/Safety Lab

Tel: 886-3-3183232

Fax: 886-3-3270892

Email: service.adt@tw.bureauveritas.com

Web Site: www.bureauveritas-adt.com

The address and road map of all our labs can be found in our web site also.

--- END ---